

Article number: 2314450651

Description: E+G polyamide wheel

RE.F8-65-PBL-N - Fixed plate in Zinc-plated steel

Measures

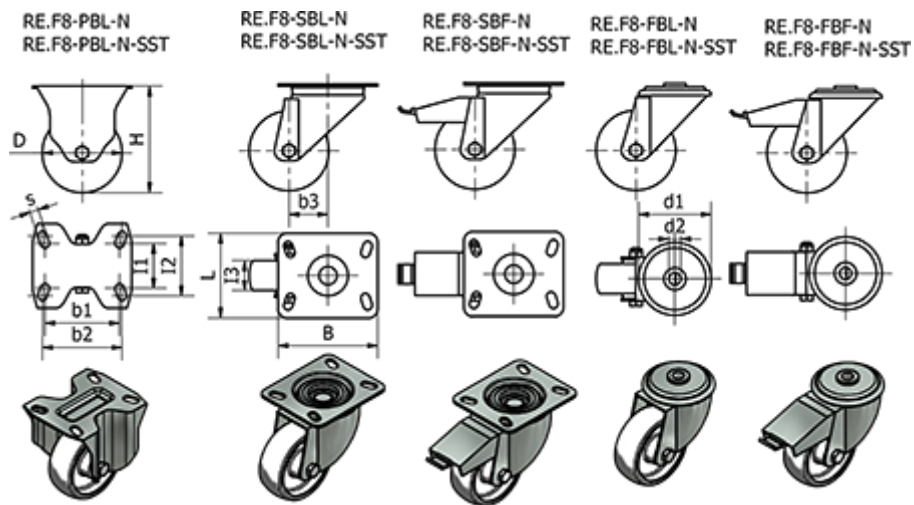

= -	d2	=	Rolling resistance (N) = 900
B = 100	Dynamic carrying capacity (N) = 1200		s = 9
b1 = 75	H = 100		Type = RE.F8-65-PBL-N
b2 = 80	l1 = 45		Wight (g) = 370
b3 =	l2 = 60		
Code = 450651	l3 = 30		
D = 65	L = 85		
d1 =	R =		